

# LP Jr SC Guitar Kit Assembly Instructions



California requires the following notice:

# **WARNING**

Some dust created by power sanding, sawing, grinding, drilling, and other construction activities contains chemicals known to the State of California to cause cancer, birth defects or other reproductive harm. Some examples of these chemicals are:

- Lead from lead-based paints.
- Crystalline silica from bricks, cement, and other masonry products.
- Arsenic and chromium from chemically treated lumber.

Your risk from these exposures varies, depending on how often you do this type of work. To reduce your exposure to these chemicals: work in a well ventilated area, and work with approved safety equipment, such as those dust masks that are specially designed to filter out microscopic particles.

## **Warning**

Always wear safety glasses or goggles when operating equipment. Everyday glasses or reading glasses are not safety glasses. Be certain the safety glasses you wear meet the appropriate standards of the American National Standards Institute (ANSI). Because there are various ways to cut and join wood, you can make substitutions for the methods stated in this manual. We try to suggest the easiest methods possible. However, only you know your skills with each piece of machinery. Never compromise your safety by using a cutting method with which you are not comfortable. Instead, find an alternative approach that will yield the same result.

## **Warning**

These instructions assume that you are familiar with the safe operation and use of woodworking machinery and woodworking tools, and understand the techniques used to assemble this project. If you do not qualify for both of these criteria, STOP building this project for your own safety. Read and understand the owner's manual for the machinery you intend to use, take a woodworking class or visit your local library for more information. Woodworking machinery and tools are inherently dangerous because they use sharp edges that can and will cause serious personal injury including amputation and death. Do not underestimate the ability of these tools and machinery to cause injury. Never operate any tool without all guards in place and always wear approved safety glasses. For your own safety, please heed this warning.

## LP Junior Single Cut Parts List

Mahogany guitar body

Mahogany with rosewood fingerboard neck

1 Electric cord, 6 strings

Jack with 4 screws

2 chrome strap buttons, 2 screws, 2 rubber washers

Wiring harness with 2 pots

1 vol knob

1 Tone knob

Electronics cover with 2 screws

Pickguard with 3 screws

### Bridge Assembly

Bridge with 2 posts

### Neck

6 tuners , 3 each side of headstock

6 small tuner screws

6 bushings and washers

Nut

Truss rod cover with 3 screws

### Pickups

Dog eared P90 pickup, 2 mounting screws, 2 springs

## Table of Contents

Introduction .....	6
Installing the tuners .....	7
Installing the set neck .....	7
Installing the Combination Bridge/Tailpiece.....	12
Installing the Pickup.....	12
To attach the pickups to the guitar body:.....	12
Wiring the pickup.....	12
Connecting the Jack .....	13
Installing the Nut.....	14
To install the nut:.....	14
Finish .....	14
The Body .....	15
Solid Color Finish.....	15
The Neck .....	15
Setup .....	16
Adjusting the Action.....	16
The Nut.....	16
The Bridge .....	16
Pickup Height .....	16
Intonation .....	16

## Introduction

Thank you for purchasing a BYOGuitar.com guitar kit. This kit includes everything you need to build a complete custom guitar.

These instructions assume you are familiar with the anatomy of a guitar. Many of the terms used are shown in the below diagram.

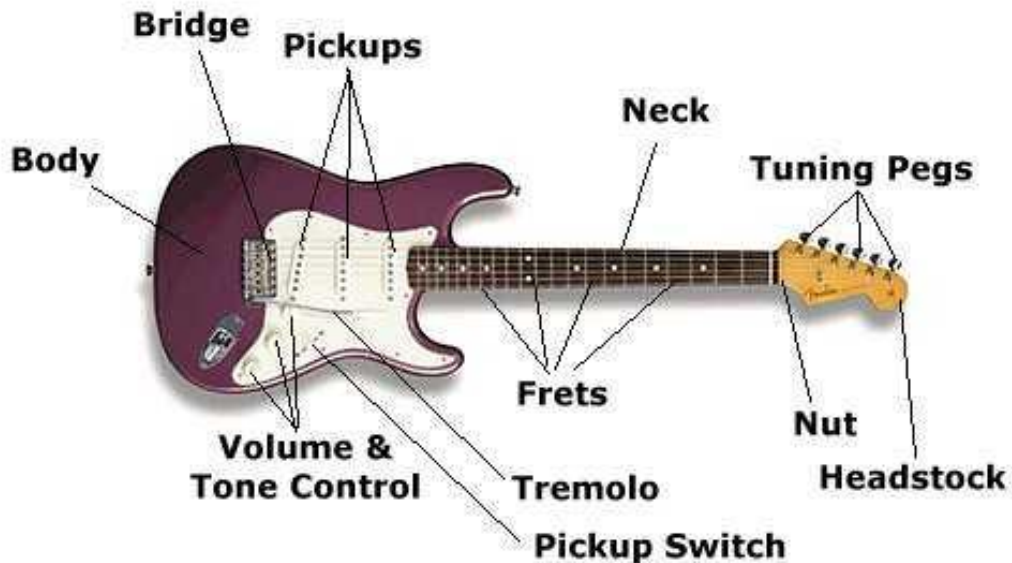

Here is the order of operations to complete the guitar:

- Fit the neck.
- Drill the mounting holes for the bridge.
- Sand the body and neck.
- Sand some more!
- Finish the body and neck.
- Assemble the guitar.
- Wire it up.
- Final set up and adjustments.
- Plug it in and enjoy!

It's recommended that you assemble your guitar before applying the finish. Drill all the holes to eliminate any accidental chipping of the finish while drilling. Fit the neck and locate the bridge before finishing the guitar. After the finish is complete all you should need to do is put it together and do some fine-tuning.

Always centerpunch the hole locations before you drill; this will ensure that the holes are properly located (very important with bridge screws). If you don't have direct access to a drill press, have a friend with a drill press drill a series of holes through a block of wood that correspond to the holes required for your bridge. Then put the block on top of the body and use it to guide your drill bit.

## Installing the tuners

Each tuner consists of the tuner, washer, and a threaded bushing. The tuners are attached to the headstock with a small wood screw that attaches between the tuners.

### To install the tuners:

1. Place the six tuners into the holes on the back of the headstock. The holes may need to be widened with a peghead reamer or a round file. DO NOT widen the holes too much—the tuners should fit snug.
2. Slide a washer over the tuner shaft and screw the threaded bushing onto the tuner.
3. Align the tuners perpendicular to the edge of the headstock and parallel to each other. Use a strip of masking tape to secure their position on the headstock.
4. Using a 1/16" drill bit in a drill press, drill 3/8" deep holes into the headstock.

*Note—Drilling the holes deeper than 3/8" could result in drilling out through the front face of the headstock. Use a depth stop or tape wrapped around the drill bit at the correct depth as an indicator.*

5. Secure the machine heads to the guitar headstock with the tap screws.

## Installing the set neck

There are a few things to consider when installing a set neck. First is the position, in and out, of the neck in the body. Second, is the alignment of the neck with the center line of the body (figure 1).

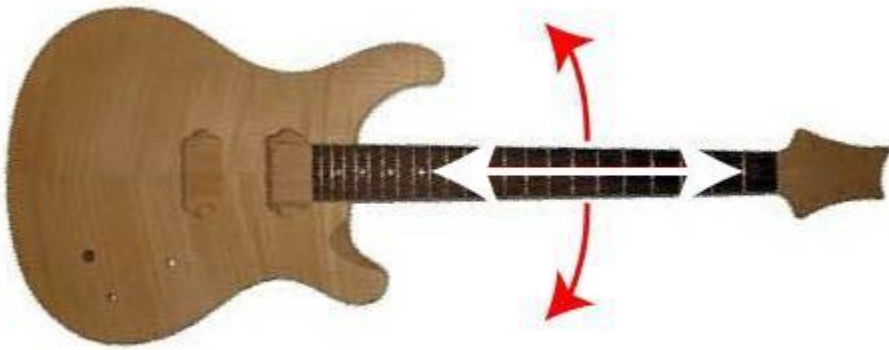

Figure 1

To determine the location of the neck in and out, it's important to understand how to determine where the neck should be located. The distance from the nut (edge closest to the fingerboard) to the 12<sup>th</sup> fret is equal to the distance from the 12<sup>th</sup> fret to the bridge (figure 2). If the bridge holes have already been drilled in the body it's important to locate the neck correctly. If the bridge holes haven't been drilled you have some leeway. Use the scale length of the neck and the bridge location to determine the neck placement. **DO NOT simply position the neck so the heel of the neck is at the back of the pickup cavity. Typically it doesn't actually reach the back of the cavity and should not be assumed to be the correct neck position.**

Distance from bridge to 12th fret = Distance from 12th fret to nut.



Figure 2



When measuring from the 12<sup>th</sup> fret to the bridge, you want to measure to the saddle on the high E string. (Figure 3) If the bridge holes are drilled with compensation (usually the case on a tune-o-matic bridge) the saddle on the high E string will be closer to the nut than the saddle on the low E string.

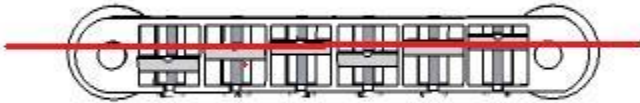

**Figure 3**

If the bridge holes haven't been drilled yet, install the neck first. Simply locate the neck so the end of the fingerboard is located correctly with respect to the front pickup. Place the pickup in the cavity and slide the neck back until it's touching the pickup mounting ring.

When you have the neck located in and out, mark it with a pencil so you can position it correctly when it is glued and clamped.

Next you need to align the neck with the center of the pickup cavities and bridge. This step is the same if you are installing a set neck or a bolt on neck. It's important to get the correct neck alignment. If the alignment isn't correct the E strings won't run parallel to the edges of the fingerboard.

Clamp two straight boards to each side of the neck and use a ruler to align the neck with the center of the bridge (figure 4). If the bridge holes are already drilled, the center is known. If they haven't been drilled, align with the center of the pickup cavities. Once you have located the neck, make a mark on the heel of the bridge and pickup cavity so you align it when gluing and clamping.



**Figure 4**

The last thing to check is the neck angle (figure 5). If the angle is not correct you won't be able to get the correct action. With the neck in the pocket, place a straight edge on the frets. Push the straight edge back until it's over the bridge. The straight edge should be just over the bridge (figure 6).



With a low bridge and no neck angle, the strings are a good playing height from the fretboard.



With a bridge that sits higher and no neck angle, the angle of the strings causes them to be too high off the fretboard for comfortable playing.

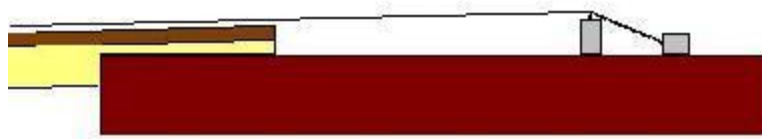

By putting the neck at an angle, the strings are moved closer to the playing surface, resulting in a better playing guitar.



However, too great of a neck angle will cause the strings to rub on the fretboard, and make the guitar unplayable!

Figure 5

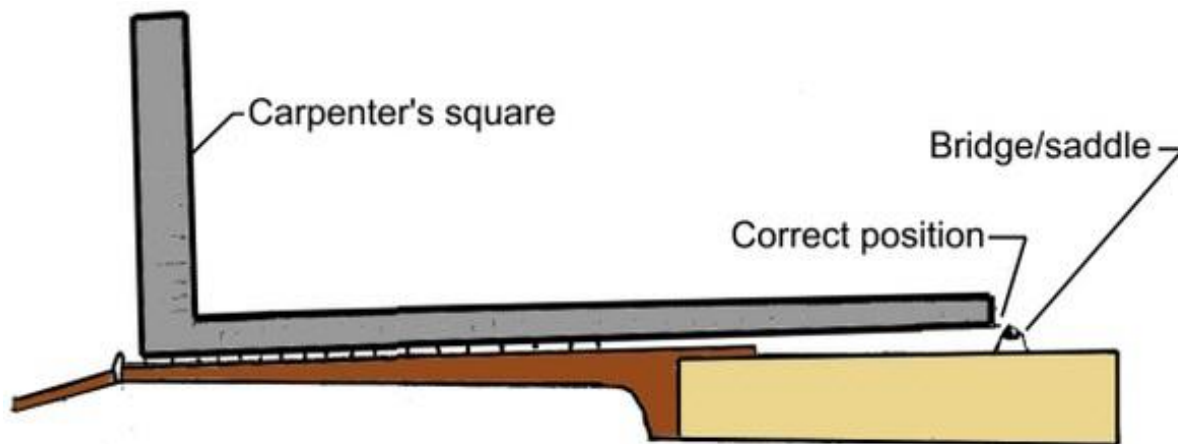

## Proper neck angle

Figure 6

Now that you know where the neck should be located all that's left is to glue it in place. Use yellow wood glue, align the neck with the marks you've made and clamp in place and allow to dry.

## **Installing the Combination Bridge/Tailpiece**

1. Place two inserts into the holes.
2. Place the wooden block on an insert and lightly tap the insert down until it touches the top of the guitar body. Repeat for the other insert.
3. Thread the bridge adjustment screws into the inserts and place the bridge on the posts.

## **Installing the Pickup**

The LPJR kit has a single P90 pickup.

### **To attach the pickups to the guitar body:**

Push the wire on the pickup through the hole to the electronics cavity. Place the pickup in the pickup cavity and lower it until it lays flat on the body. Position the pickup so it's centered under the strings and perpendicular to centerline of the body.

Mark the locations of the holes. Remove the pickups and drill pilot holes for the pickup mounting screws.

### **Wiring the pickup**

This guitar comes with a wiring harness that has most of the components soldered in place. You only need to solder in the pickup wires onto the volume pot. Use the wiring diagram in figure 7 for reference. All the wire that are labeled GND should be soldered to the back of one of the pots.

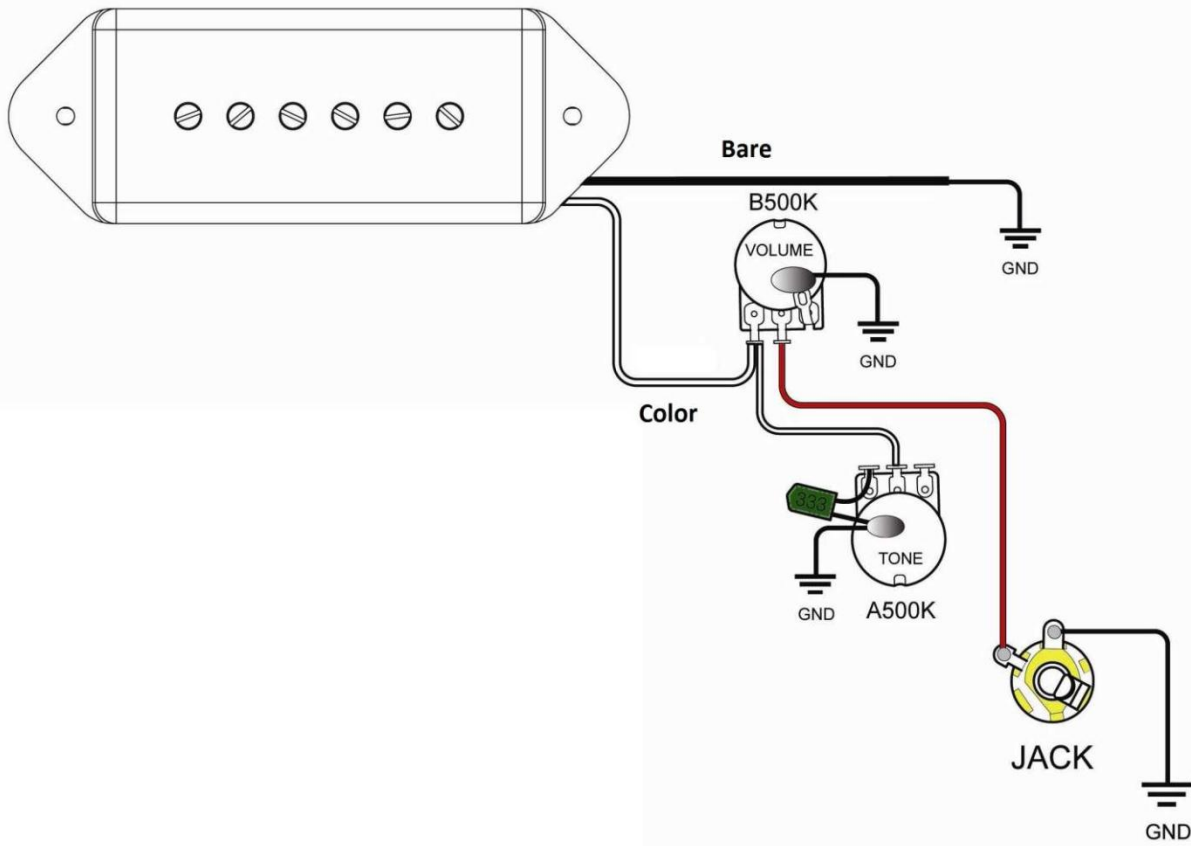

Figure 7

## Connecting the Jack

Follow the diagram in figure 7 for proper wiring of the jack. Figure 8 shows a jack from a Stat guitar, but the connection to the jack from the pots is the same.

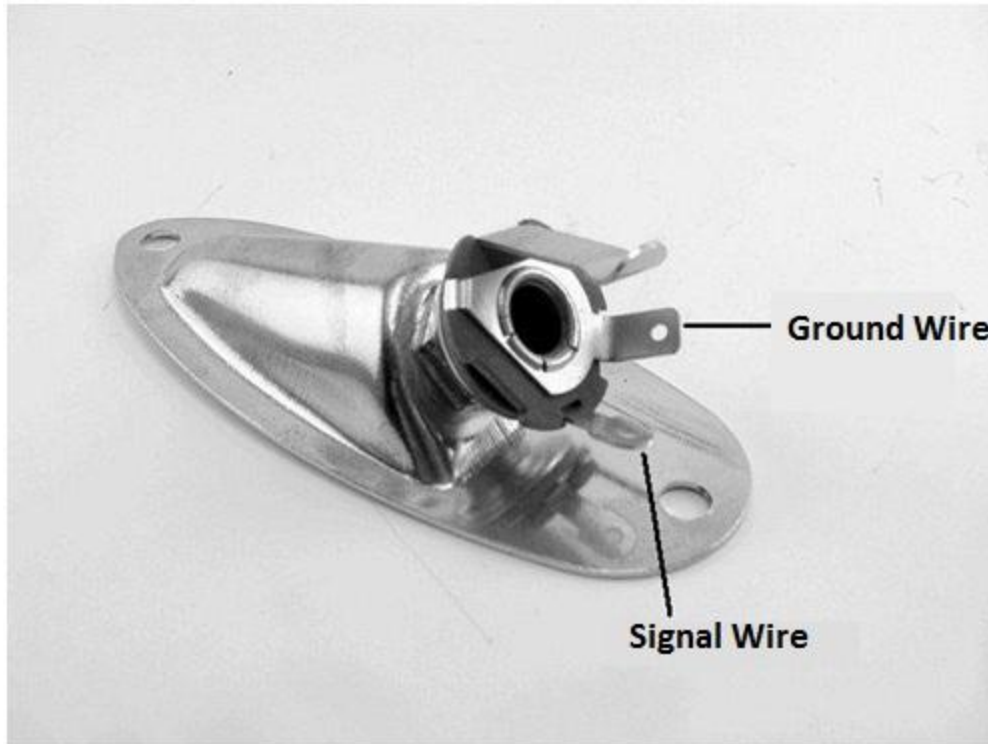

Figure 8

## Installing the Nut

The nut holds the string at the peghead the correct distance above the frets. It is not necessary to cut the string notches in the nut that comes with this kit.

### To install the nut:

1. Use a chisel or razor blade to scrape any finish out of the nut slot. DO NOT remove any wood from the nut slot.
2. Spread a thin layer of wood glue in the nut slot and center the nut in the nut slot.
3. Install the strings
4. The strings will hold the nut in place until the glue dries.
5. Wipe away the excess glue before it sets up, then allow the glue to dry for 24 hours.

## Finish

Before starting the finish make sure all holes are drilled for any remaining hardware (pickguard, jack plate, strap pins etc).

## The Body

Sand the body and neck with #220 dry sandpaper, followed by #320. If you are applying a finish, other than natural, you should consider using a grain filler on the body. This will fill in the valleys in the grain and result in a nice flat surface allowing you to get a nice high gloss finish. An oil based grain filler is recommended. For most finishes use a natural colored filler. The dyes used in darker fillers may over time find their way through the color coat. We carry a full line of Behlen Por-o-pac grain fillers that work perfectly for smoothing out your guitar body.

Apply the filler by wiping across the grain. You can use a course cloth or your fingers to wipe the grain in. After it has dried about ten to twenty minutes the excess can be removed with a cloth dampened with mineral spirits. After about an hour repeat the process and let dry overnight. If you have removed most of the excess with mineral spirits the remaining filler on the field of the wood can be sanded off (use #220 again) in a few minutes. It is also a good idea at this time to reopen any of the screw holes in the body. Use a toothpick or small drill held between your fingers to clean out any filler in the holes. The body is now ready for a sand and sealer coating.

Sand and sealer is used to give the final coat a level base. It is also helpful in filling scratches which are too deep to sand out.

## Solid Color Finish

The last step before applying the color coats is to apply a white primer coat. B.I.N.s makes a white pigmented shellac in an aerosol can that will cover the grain and prevent any previous finishes from bleeding through. The white background will also let you apply an opaque color coat with less paint. You can find this sealer at most hardware stores and again, at Home Depot. Spray on two coats. When dry you may notice that the surface feels rough. Sand off the roughness with #320 dry and respray. Sand again. If the surface now appears smooth and all grain is opaqued you are ready for the color coat.

We carry a full line of finishing products to give you the beautiful finish you are looking for, whether a clear natural finish or a bold, colorful finish. We also carry an instructional DVD made by Behlen that will give you step by step instructions to help you achieve the look you want for your custom guitar.

## The Neck

On a maple fingerboard you can apply a clear finish to the entire neck and fingerboard. Apply several coats and remove buildup on the frets between coats. An easy way to remove the finish buildup on the frets is to take a nail and file a half round slot in the head about the same size as the frets. You can then use this to easily scrape any finish build up.

If the neck has a Rosewood or Ebony fingerboard be sure to tape off the fingerboard before applying the finish.

## Setup

### Truss Rod

First, check your tuning. Put a capo at the first fret and press the sixth string at the last fret. With a feeler gauge, check the gap between the bottom of the string and the top of the 8th fret—you should have about  $4/64^{\text{th}}$

Sight down the edge of the fingerboard from behind the headstock, looking toward the body of the guitar. If the neck is too concave (action too high), turn the truss rod nut clockwise to remove excess relief (only adjust  $1/4$  turn at a time) If the neck is too convex (strings too close to the fingerboard), turn the truss rod nut counter-clockwise to allow the string tension to pull more relief into the neck. Check your tuning, then re-check the gap with the feeler gauge and re-adjust as needed.

### Adjusting the Action

#### The Nut

Setting the string action that is right for you starts at the nut. The slots should already be close, but you might want to make some adjustments.

Push the sixth string down between the second and third fret. The space between the first fret and the bottom of the string should be about .006 or just about the thickness of two sheets of paper. If the gap is wider than .006" you should deepen the slot with a small needle file. **DO NOT FILE TOO DEEP!** Make sure when you file, the file is angled down toward the headstock. This will ensure the string sits on the edge of the nut closest to the fretboard.

Repeat the procedure for the remaining 5 strings.

#### The Bridge

This will adjust the height of the strings over the 12<sup>th</sup> fret. Minor adjustments are made by raising or lowering the bridge. This adjustment is a matter of personal preference. There should be a gradual increase in height from the first string to the sixth string.

#### Pickup Height

Each pickup is adjustable on the bass and treble sides. Finding the best combination of tone and volume will require some experimentation. A good place to start is to adjust the pickup height so the first string is  $1/8$ " over the pickup pole and the sixth string is about  $3/16$ " over its pole.

#### Intonation

Adjustments should be made after all of the above have been accomplished. Set the pickup selector switch in the middle position, and turn the volume and tone controls to their maximum settings. Check tuning. Check each string at the 12th fret, harmonic to fretted note (make sure you are depressing the string evenly to the fret, not the fingerboard). If sharp, lengthen the string by adjusting the saddle back.



If flat, shorten the string by moving the saddle forward. Remember, guitars are tempered instruments! Re-tune, play and make further adjustments as needed.

We hope you have enjoyed building your guitar! If you have any questions along the way please email us at [support@byguitar.com](mailto:support@byguitar.com).